

**Boost Converter with USB Power Switch**

**General Description**

The AAT1275 SwitchReg is a 2MHz, 500mA synchronous boost converter with an integrated current-limiting load switch controlled output. The AAT1275 operates from a single-cell Lithium-ion/ polymer battery source and provides a regulated 5V, current limit controlled output to support USB port  $V_{BUS}$  applications in portable consumer electronic products. The AAT1275 can support both USB 2.0 host port and USB on-the-go operation, as well as general purpose applications where a 5V supply with a user programmable current limit is needed.

The high efficiency boost converter section of the AAT1275 is typically set for a 5V output and can deliver up to 500mA load current to support USB  $V_{BUS}$  operation from an input supply as low as 2.7V. The high boost converter switching frequency (up to 2.0MHz) provides fast load transient and allows the use of small external components. Fully integrated control circuitry simplifies system design and reduces total solution size.

The integrated, programmable current limiting load switch provides USB port protection for portable devices allowing the AAT1275 to supply a 5V USB  $V_{BUS}$  up to 500mA. The load switch provides an active low fault flag to alert the system in the event of an over-current condition applied to the AAT1275 output.

The AAT1275 is available in the Pb-free, space-saving 12-pin TSOPJW and 16-pin TDFN34 packages and is rated over the -40°C to +85°C operating temperature range.

**Features**

- High Frequency Boost With 5V / 500mA Output Capability From a Single-Cell Lithium-Ion/Polymer Battery
- Input Voltage Range: 2.7V to 5V
- $V_{OUT1}$  Adjustable
- >90% Efficiency
- Up to 2MHz Switching Frequency
- True Load Disconnect
- Load Switch With Programmable Current Limit
- Over-Temperature, Over-Current Protection
- Inrush Current Limit
- Fault Report
- Low Shutdown Current < 1µA Typical
- -40°C to +85°C Temperature Range
- TSOPJW-12 and TDFN34-16 Packages

**Applications**

- USB On-the-Go
- Cell Phones
- Digital Still Cameras
- PDAs and Portable Media Players
- Smart Phones
- Other Hand-Held Devices

**Typical Application**

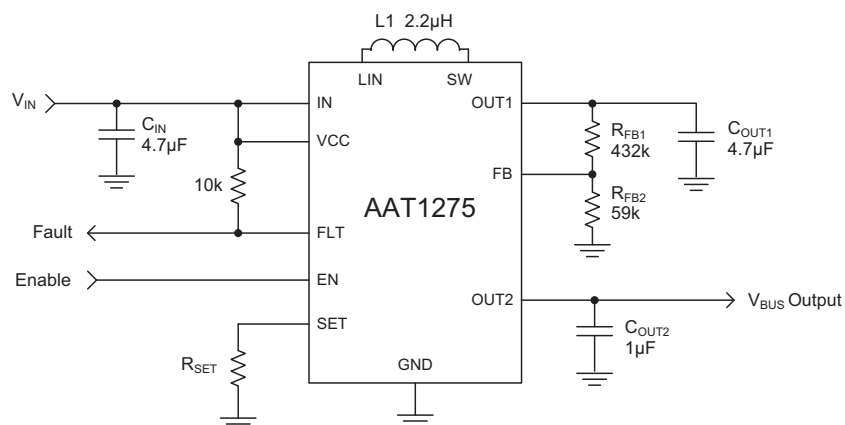

# AAT1275

## Boost Converter with USB Power Switch

### Pin Descriptions

Pin		Symbol	Function
TSOPJW-12	TDFN34-16		
1	1, 16	LIN	Switched power input. Connect an inductor between this pin and the SW pin.
2	3, 15	IN	Supply input. Connect to VCC for proper operation.
3	13, 14	PGND	Power ground.
4	11, 12	SW	Switch pin. Boost inductor is connected between SW and LIN.
5	10	OUT1	Boost converter output.
6	9	OUT2	Load switch output.
7	8	SET	Load switch current limit programming pin. Connect a set resistor between this pin and ground.
8	7	FLT	Load switch over-current or over-temperature fault flag. Active low, open-drain output. A 10kΩ external pull-up resistor is recommended.
9	6	FB	Boost converter voltage feedback pin.
10	5	GND	Ground.
11	4	VCC	Bias supply for the internal circuitry. Connect to IN for proper operation.
12	2	EN	Enable pin, active high.
		EP	Exposed paddle (bottom); connect to ground directly beneath the package.

### Pin Configuration

**TSOPJW-12  
(Top View)**

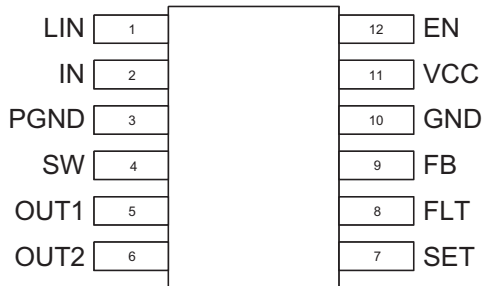

**TDFN34-16  
(Top View)**

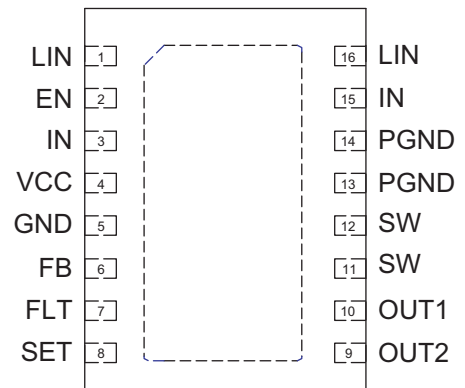

**Boost Converter with USB Power Switch****Absolute Maximum Ratings**

Symbol	Description	Value	Units
VCC, IN, OUT	IN, OUTx to GND	6.0	V
SW	SW to GND	-0.3 to $V_{OUT} + 0.3$	V
LIN, FB	LIN, FB to GND	-0.3 to $V_{IN} + 0.3$	V
EN, SET, FLT	EN, SET, FLT to GND	-0.3 to $V_{IN} + 0.3$	V
$T_J$	Operating Junction Temperature Range	-40 to 150	°C
$T_{LEAD}$	Maximum Soldering Temperature (at leads, 10 sec)	300	°C

**Thermal Characteristics<sup>1</sup>**

Symbol	Description	Value	Units
$\theta_{JA}$	Maximum Thermal Resistance	TSOPJW-12	110
		TDFN34-16	50
$P_D$	Maximum Power Dissipation @ $T_A = 25^\circ\text{C}$	TSOPJW-12	909
		TDFN34-16	2.0

1. Mounted on an FR4 board.

# DATA SHEET

# AAT1275

## Boost Converter with USB Power Switch

### Electrical Characteristics<sup>1</sup>

$V_{CC} = V_{IN} = 3.6V$ ,  $V_{OUT1} = 5V$ ,  $T_A = -40^{\circ}C$  to  $+85^{\circ}C$ , unless otherwise noted. Typical values are at  $T_A = 25^{\circ}C$ .

Symbol	Description	Conditions	Min	Typ	Max	Units
$V_{IN}, V_{CC}$	Operating Input Voltage Range		2.7		5.0	V
$V_{OUTx}$	Maximum Output Voltage Range				5.5	V
$V_{UVLO}$	Under-Voltage Lockout				2.7	V
$I_Q$	Quiescent Supply Current	No Load, Switching		100		$\mu A$
		No Load, Not Switching, $V_{FB} = 1.5V$		45	90	
$I_{SHDN}$	Shutdown Current	EN = GND			1.0	$\mu A$
<b>Boost Converter</b>						
$I_O$	Continuous Output Current	$3V < V_{IN} < 5V, V_O = 5V$			500	mA
$I_{LIMIT}$	Input Switch Current Limit			2.5		A
$V_{FB}$	FB Pin Regulation	No Load, $T_A = 25^{\circ}C$	0.591	0.6	0.609	V
$V_{OUT}$	Output Voltage Tolerance	$I_{LOAD} = 0$ to 500mA, $V_{IN} = 2.7V$ to 5V	-3		3	%
$\frac{\Delta V_{OUT}}{V_{OUT} * \Delta V_{IN}}$	Load Regulation	$I_{LOAD} = 0$ to 500mA		0.005		%/mA
$\frac{\Delta V_{OUT}}{V_{OUT}}$	Line Regulation	$V_{IN} = 2.7V$ to 5V		0.2		%/V
$R_{DS(ON)H}$	High Side Switch On Resistance	$V_{OUT1} = 5V, I_{OUT1} = 500mA$		200		m $\Omega$
$R_{DS(ON)L}$	Low Side Switch On Resistance	$V_{OUT1} = 5V, I_{OUT1} = 500mA$		170		m $\Omega$
$R_{DS(ON)_IN}$	Input Disconnect Switch	$V_{OUT1} = 5V, I_{OUT1} = 500mA$		170		m $\Omega$
$T_{SS}$	Soft-Start Time	From Enable to Output Regulation		300		$\mu s$
$\eta$	Efficiency	$I_{OUT1} = 250mA, L = 2.2\mu H, V_{IN} = 3.6V, V_{OUT1} = 5V$		90		%
$F_{OSC}$	Switching Frequency	$T_A = 25^{\circ}C, I_{OUT1} = 500mA, V_{IN} = 3.6V, V_{OUT1} = 5V$		2.0		MHz
<b>Load Switch</b>						
$R_{DS(ON)}$	Current Limit Switch On Resistance	$V_{OUT1} = 5V, T_A = 25^{\circ}C$			0.2	$\Omega$
$I_{LIM}$	Current Limit	$R_{SET} = 16.9k\Omega$		500	625	mA
$I_{LIM(MIN)}$	Minimum Current Limit	$R_{SET} = 40k\Omega$		100		mA
$T_{RESP}$	Current Limit Response Time	$V_{OUT1} = 5V$		0.4		$\mu s$
$T_{ON}$	Turn-On Delay Time	$V_{OUT1} = 5V, R_L = 10\Omega$		4		ms
$T_{OFF}$	Turn-Off Delay Time	$V_{OUT1} = 5V, R_L = 10\Omega$		10		$\mu s$
$V_{FLT\_LOW}$	FLT Logic Output Low	$I_{SINK} = 1mA$			0.4	V
$I_{FLT}$	FLT Logic Output High Leakage Current	$V_{FAULT} = 5V$		0.5	1	$\mu A$
$T_{BLANK}$	Fault Blanking Time	Rising and Falling Edge		4		ms
<b>Control</b>						
$V_{TH-L}$	EN Threshold Low				0.4	V
$V_{TH-H}$	EN Threshold High		1.4			V
$I_{EN}$	EN Input Leakage	$V_{EN} = 5V, V_{IN} = 5V$	-1		1	$\mu A$
$T_{J-TH}$	TJ Thermal Shutdown Threshold			140		$^{\circ}C$
$T_{J-HYS}$	TJ Thermal Shutdown Hysteresis			15		$^{\circ}C$

1. The AAT1275 is guaranteed to meet performance specifications over the  $-40^{\circ}C$  to  $+85^{\circ}C$  operating temperature range and is assured by design, characterization, and correlation with statistical process controls.

### Typical Characteristics

**Efficiency vs. Load**

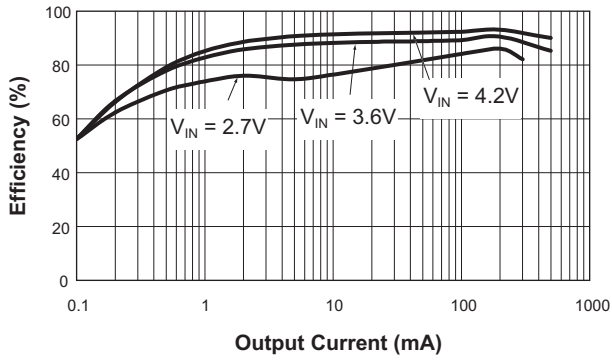

**DC Regulation**  
( $V_{OUT} = 5.0V$ )

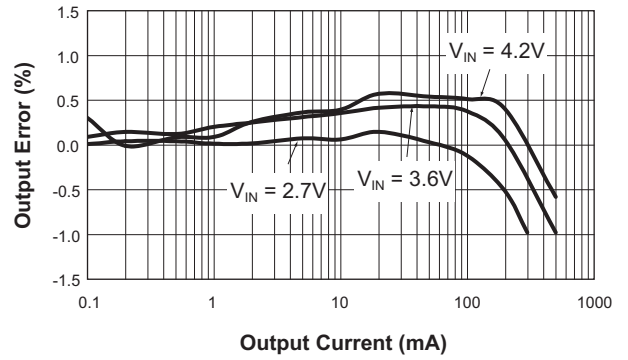

**Line Regulation**  
( $I_{OUT} = 300mA$ )

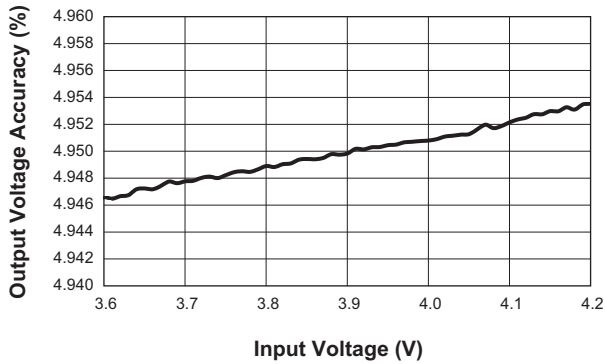

**Output Voltage vs. Temperature**  
( $V_{IN} = 3.6V$ ;  $50\Omega$  Load)

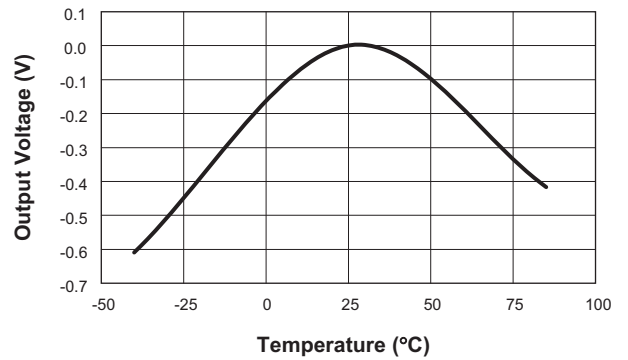

**No Load Current vs. Supply Voltage**

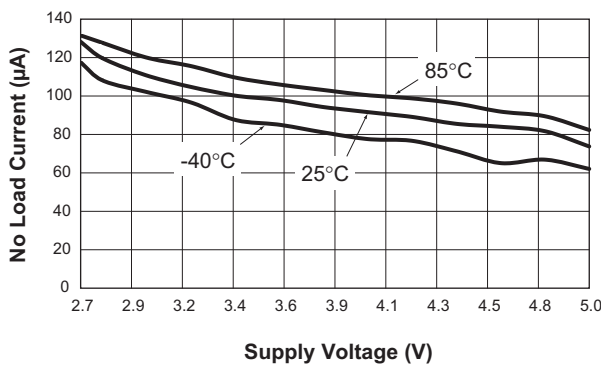

**No Load Current vs. Temperature**  
( $V_{IN} = 3.6V$ ;  $V_{OUT} = 5.0V$ )

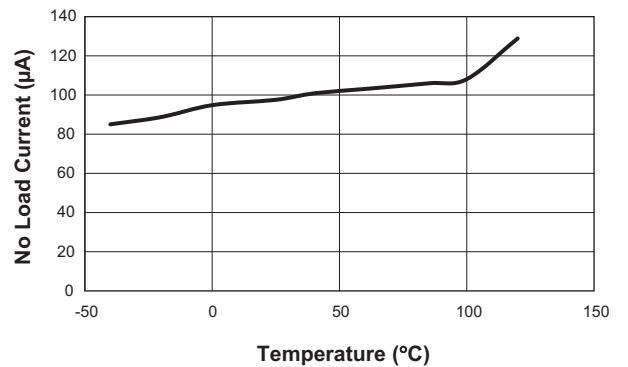

### Typical Characteristics

**Light Load Switching Waveform**  
( $V_{IN} = 3.6V$ ;  $V_{OUT} = 5.0V$ ; 10mA Load)

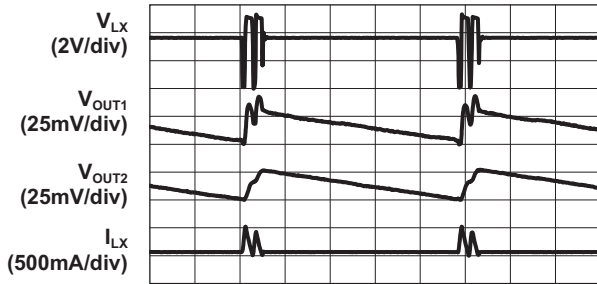

Time (5µs/div)

**Heavy Load Switching Waveform**  
( $V_{IN} = 3.6V$ ;  $V_{OUT} = 5.0V$ ; 500mA Load)

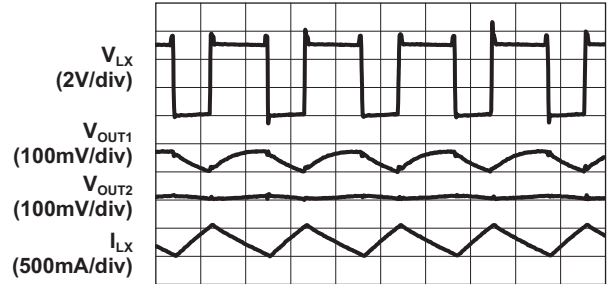

Time (500ns/div)

**Load Transient Response**  
( $V_{IN} = 3.6V$ ;  $V_{OUT} = 5.0V$ )

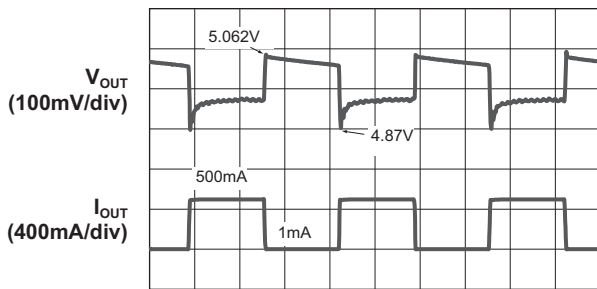

Time (100µs/div)

**Load Transient Response**  
( $V_{IN} = 3.6V$ ;  $V_{OUT} = 5.0V$ )

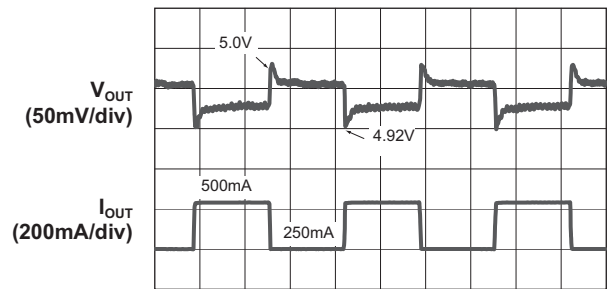

Time (100µs/div)

**Line Transient Response**  
(16Ω Load)

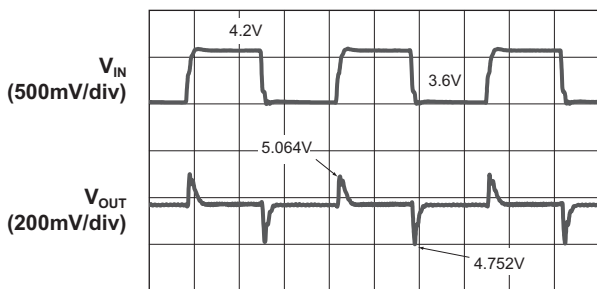

Time (100µs/div)

**Load Switch  $R_{DS(ON)}$  vs. Input Voltage**

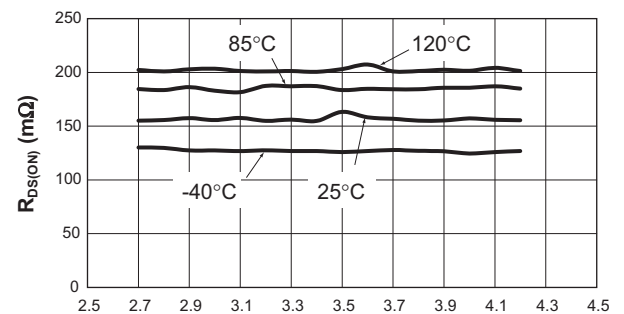

Supply Voltage (V)

### Typical Characteristics

**P-Channel  $R_{DS(ON)}$  vs. Supply Voltage**

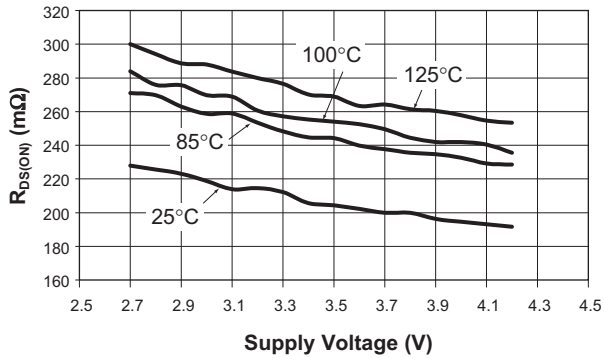

**N-Channel  $R_{DS(ON)}$  vs. Supply Voltage**

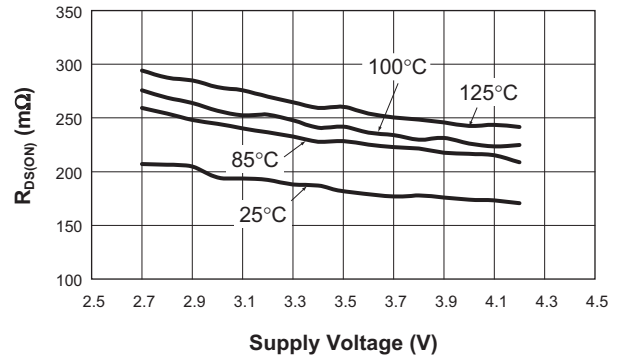

**Enable Soft Start**  
( $V_{IN} = 3.6V$ ; 500mA Load)

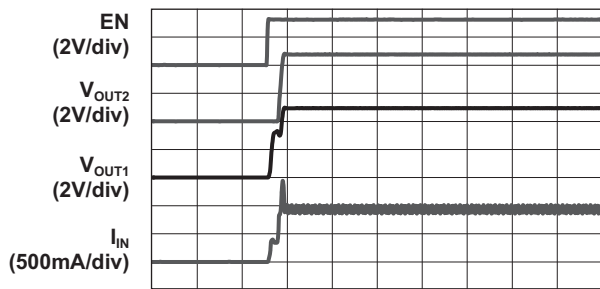

Time (1ms/div)

**Enable Soft Start**  
( $V_{IN} = 4.2V$ ; 500mA Load)

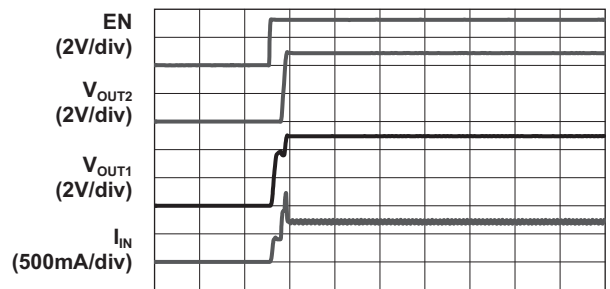

Time (1ms/div)

**Enable Soft Start**  
( $V_{IN} = 3.6V$ ;  $C_{VOUT2} = 120\mu F$ ; 16Ω Load)

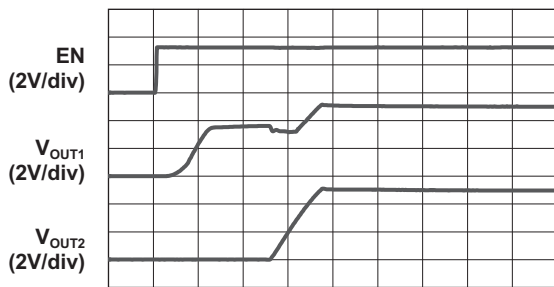

Time (100μs/div)

**Shutdown**  
( $V_{IN} = 3.6V$ ;  $C_{VOUT2} = 120\mu F$ ; 16Ω Load)

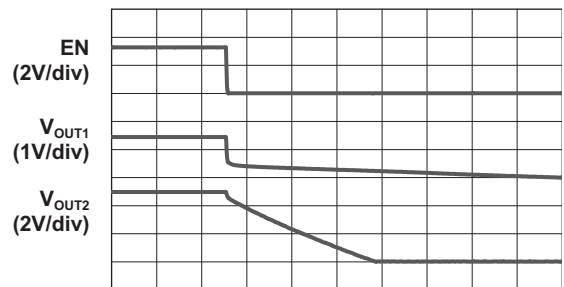

Time (50ms/div)

### Typical Characteristics

Current Limit vs.  $R_{SET}$

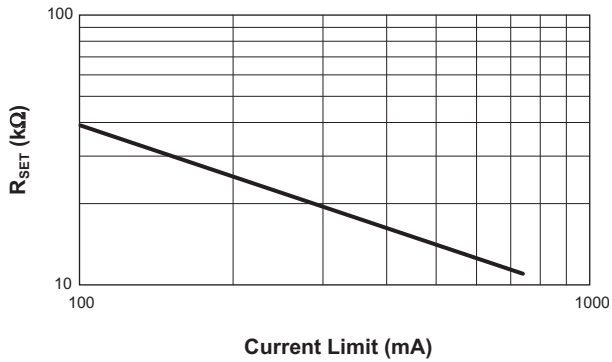

Current Limit vs. Temperature  
( $R_{SET} = 20.3k\Omega$ )

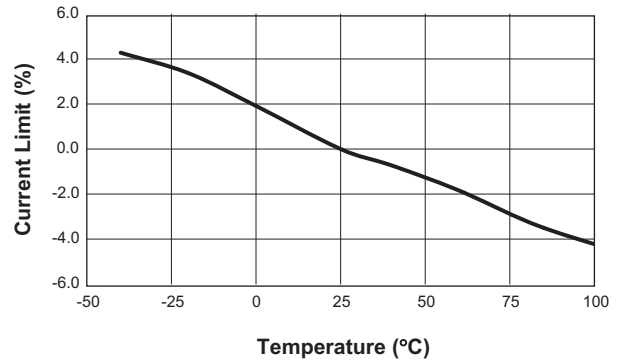

Switching Frequency vs. Input Voltage  
(24W Load;  $L = 2.2\mu H$ )

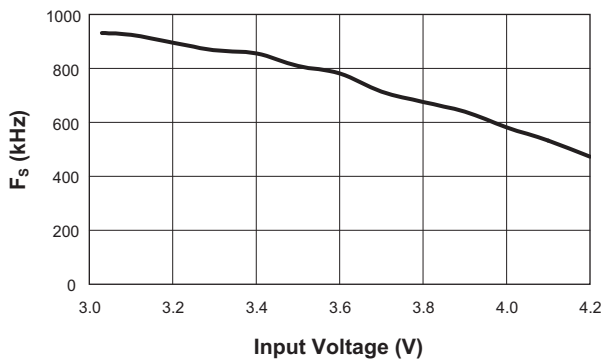

Switching Frequency vs. Temperature  
( $V_{IN} = 3.6V$ ;  $16.5\Omega$  Load;  $L = 2.2\mu H$ )

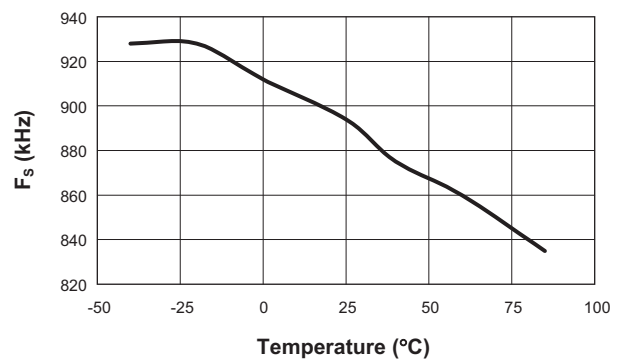

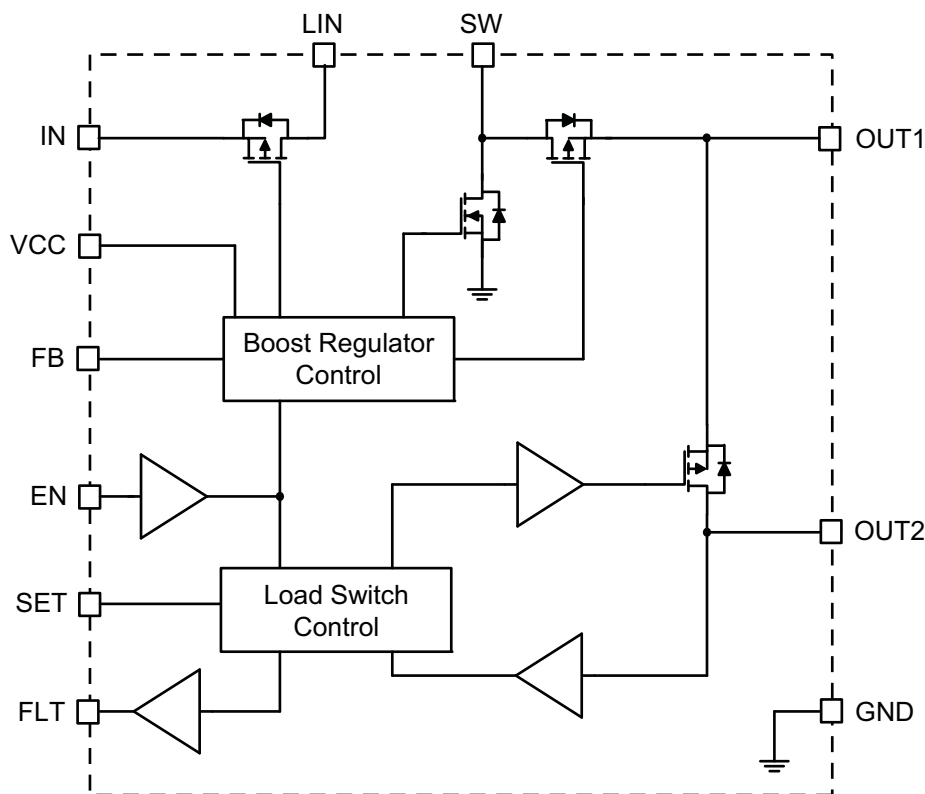

**Functional Block Diagram****Functional Description**

The AAT1275 is a 500mA synchronous boost converter with a current-limited load switch targeted for single-cell Lithium-ion/polymer devices acting as a portable host for USB power.

The AAT1275 has integrated control and synchronous MOSFETs, minimizing the cost and the number of external components. Additional features include a soft-start function which allows the load voltage to ramp up in a controlled manner, eliminating output voltage overshoot and minimizing inrush current. Typical soft-start time for the boost converter is approximately 300 $\mu$ s.

The AAT1275 also has a load switch with user-programmable current limiting. The load switch reports over-current and over-temperature conditions through an

open-drain fault reporting signal (FLT). The fault reporting signal has a 4ms turn-on delay.

**Control Scheme**

The control circuit uses hysteretic current mode control with internal inductor current sensing for very high efficiency over a wide output current range. For heavy load, the boost converter operates in continuous conduction mode (CCM). This minimizes the RMS current and optimizes the efficiency at load conditions where the losses are dominated by the power MOSFET  $R_{DS(ON)}$ . This also keeps the ripple current to a minimum and minimizes the output voltage ripple and the output capacitor size. A zero current comparator senses the inductor current and prevents reverse current flow for optimum light load efficiency.

**Boost Converter with USB Power Switch****Step-Up Converter  
Application Information**

The AAT1275 step-up converter provides the benefits of current mode control with a simple hysteretic feedback loop. The device maintains exceptional DC regulation, transient response, and cycle-by-cycle current limit without additional compensation components. The AAT1275 modulates the power MOSFET switching current in response to changes in output voltage. The voltage loop programs the required inductor current in response to changes in the output load and input voltage.

The switching cycle initiates when the N-channel MOSFET is turned ON and the inductor current ramps up. The ON interval is terminated when the inductor current reaches the programmed peak current level. During the OFF interval, the input current decays until the lower threshold, or zero inductor current is reached. The lower current is equal to the peak current minus a preset hysteresis threshold, which determines the inductor ripple current. The peak current is adjusted by the controller until the output current requirement is met.

The magnitude of the feedback error signal determines the average input current. Therefore, the AAT1275 boost controller implements a programmed current source connected to the output capacitor and load resistor. There is no right-half plane zero, and loop stability is achieved with no additional external compensation components.

At light load, the inductor OFF interval current goes to zero and the boost converter enters discontinuous mode operation. Further reduction in the load results in a corresponding reduction in the switching frequency, which reduces switching losses and maintains high efficiency at light loads.

The operating frequency varies with changes in the input voltage, output voltage, and inductor size. Once the boost converter has reached continuous mode, increasing the output load will not significantly change the operating frequency. A small 2.2 $\mu$ H ( $\pm$  20%) inductor is selected to maintain high frequency operation for the 5V USB output voltage.

**Output Voltage Programming**

The output voltage is programmed through a resistor divider network located from the OUT1 output capacitor to the FB pin to ground.

**Soft Start / Enable**

The input disconnect switch is activated when a valid input voltage is present and the EN pin is pulled high. The slew rate control on the P-channel MOSFET ensures minimal inrush current as the output voltage is charged to the input voltage prior to switching of the N-channel power MOSFET. The soft-start circuitry guarantees monotonic turn-on and eliminates output voltage overshoot across the full input voltage range for all load conditions.

**Input Current Limit and  
Over-Temperature Protection**

The switching of the N-channel MOSFET terminates when input current limit of 2.5A (typical) is exceeded. This minimizes the power dissipation and component stresses under overload and short-circuit conditions. Switching resumes when the current decays below the limit.

Thermal protection disables the AAT1275 boost converter when the internal power dissipation becomes excessive. The junction over-temperature threshold is 140°C with 15°C of temperature hysteresis. The output voltage automatically recovers when the over-temperature or over-current fault condition is removed.

**Shutdown and Output Disconnect**

A typical synchronous step-up (boost) converter has a conduction path from the input to the output via the body diode of the P-channel MOSFET. The AAT1275 design disconnects this body diode from the output and eliminates this conduction path. This enables the AAT1275 to provide true load disconnect during shutdown and inrush current limit at turn-on.

**Short-Circuit Protection**

The P-channel synchronous MOSFET body diode disconnect feature also gives the AAT1275 the ability to provide output short-circuit current limit protection.

**Under-Voltage Lockout**

Under-voltage lockout (UVLO) guarantees sufficient  $V_{IN}$  bias and proper operation of all internal circuitry prior to soft start. Internal bias of all circuits is controlled via the VCC input, which is connected to  $V_{IN}$ .

**Boost Converter with USB Power Switch****Selecting the Boost Inductor**

The AAT1275 boost controller utilizes hysteretic control and the switching frequency varies with output load and input voltage. The value of the inductor determines the maximum switching frequency of the boost converter. Increasing output inductance decreases the switching frequency, resulting in higher peak currents and increased output voltage ripple. To maintain the 2MHz switching frequency and stable operation, an output inductor sized from 1.5µH to 2.7µH is recommended. Manufacturer's specifications list both the inductor DC current rating, which is a thermal limitation, and peak inductor current rating, which is a function of the saturation characteristics.

Measure the inductor current at full load and high ambient temperature to ensure that the inductor does not saturate or exhibit excessive temperature rise. Select the output inductor (L) to avoid saturation at the minimum input voltage and maximum load. The RMS current flowing through the boost inductor is equal to the DC plus AC ripple components. The maximum inductor RMS current occurs at the minimum input voltage and the maximum load. Use the following equations to calculate the maximum peak and RMS current:

$$D_{MAX} = \frac{V_O - V_{IN(MIN)}}{V_O}$$

$$I_{PP} = \frac{V_{IN(MIN)} \cdot D}{L \cdot F_S}$$

$$I_P = \frac{I_O}{1 - D}$$

$$I_{PK} = I_P + \frac{I_{PP}}{2}$$

$$I_V = I_P - I_{PP}$$

$$I_{RMS} = \sqrt{\frac{I_{PK}^2 + I_{PK} \cdot I_V + I_V^2}{3}}$$

$$P_{LOSS(INDUCTOR)} = I_{RMS}^2 \cdot DCR$$

At light load and low output voltage, the controller reduces the operating frequency to maintain maximum efficiency. As a result, further reduction in output load does not reduce the peak current. The minimum peak current ranges from 0.5A to 0.75A.

Compare the RMS current values with the manufacturer's temperature rise, or thermal derating guidelines. For a given inductor type, smaller inductor size leads to an increase in DCR winding resistance and, in most cases, increased thermal impedance. Winding resistance degrades boost converter efficiency and increases the inductor's operating temperature.

Shielded inductors provide decreased EMI and may be required in noise sensitive applications. Unshielded chip inductors provide significant space savings at a reduced cost compared to shielded inductors. In general, chip-type inductors have increased winding resistance (DCR) when compared to shielded, wound varieties.

**Selecting the Step-Up Converter Capacitors**

The high output ripple inherent in the boost converter necessitates low impedance output filtering. Multi-layer ceramic (MLC) capacitors provide small size, adequate capacitance, with low parasitic equivalent series resistance (ESR) and equivalent series inductance (ESL). This makes them well suited for use with the AAT1275. MLC capacitors of type X7R or X5R ensure good capacitance stability over the full operating range. MLC capacitors exhibit significant capacitance reduction with an applied DC voltage. Output ripple measurements can confirm that the capacitance used meets the specific ripple requirements. Voltage derating minimizes this factor, but results may vary with package size and among specific manufacturers.

Use a 4.7µF 10V ceramic output capacitor to minimize output ripple for the 5V output. Small 0805 sized ceramic capacitors are available which meet these requirements.

Estimate the output capacitor required at the minimum switching frequency ( $F_S$ ) of 800kHz (worst-case).

$$C_{OUT} = \frac{I_{OUT} \cdot D_{MAX}}{F_S \cdot \Delta V_{OUT}}$$

The boost converter input current flows during both ON and OFF switching intervals. The input ripple current is less than the output ripple and, as a result, less input capacitance is required. A ceramic output capacitor from 1µF to 4.7µF is recommended. Minimum 6.3V rated capacitors are required at the input. Ceramic capacitors sized as small as 0603 are available which meet these requirements.

## Boost Converter with USB Power Switch

### Setting the Output Voltage

Program the output voltage through a resistive divider located from the output to the FB pin to ground. The internal error amplifier reference voltage is 0.6V. A 59.0kΩ programming resistor value from VFB to GND with a 432kΩ resistor from FB to the output will set the output voltage to 5V.

$$\begin{aligned} V_{OUT} &= V_{REF} \cdot \left(1 + \frac{R2}{R3}\right) \\ &= 0.6V \cdot \left(1 + \frac{432k\Omega}{59.0k\Omega}\right) \\ &= 5.0V \end{aligned}$$

### USB Load Switch Application Information

#### Setting the Load Switch Current Limit

In most applications, the variation in  $I_{LIM}$  must be taken into account when determining  $R_{SET}$ . The  $I_{LIM}$  variation is due to processing variations from part to part, as well as variations in the voltages at OUT1 and OUT2, plus the operating temperature. The typical  $R_{SET}$  value for a 300mA load is in the range of 20 to 22kΩ.

$R_{SET}$ (kΩ)	$I_{OUT}$ (mA)
11	740
12	690
14	590
16	550
18	450
20	420
30	160
40	100

Table 1: Load Switch Current Limit vs.  $R_{SET}$ .

#### Operation in Current Limit

When a heavy load is applied to OUT2 of the AAT1275, the load current is limited to the value of  $I_{LIM}$  (determined by  $R_{SET}$ ) causing a drop in the output voltage. This increases the AAT1275 power dissipation and die temperature. When the die temperature exceeds the over-temperature limit, the AAT1275 shuts down until it has cooled sufficiently, at which point it will start up again. The AAT1275 will continue to cycle on and off until the load is removed, power is removed, or until a logic low level is applied to the EN pin.

A fault flag indicates when the OUT2 pin load current has exceeded the current limit level set by  $R_{SET}$ . The fault flag is an active low, open-drain pin that requires 10kΩ pull-up to  $V_{IN}$ . The fault signal has a 4ms blanking time to prevent false over current indicator during the charging of the USB bus capacitor.

#### Steady-State Maximum Power Dissipation

The maximum power dissipation for the AAT1275 occurs at the minimum input voltage, where it operates in continuous conduction mode (CCM). The total power dissipation at full load is dominated by the  $R_{DS(ON)}$  losses of the power MOSFET. The dissipation includes the losses in the input and output switch, as well as both synchronous switches.

Due to the magnitude of the inductor ripple current, it cannot be neglected when analyzing the  $R_{DS(ON)}$  power dissipation. Once the ripple current has been determined, the RMS current during the on and the off period can be calculated.

$$D_{MAX} = \frac{V_O - V_{IN(MIN)}}{V_O}$$

$$I_{PP} = \frac{V_{IN(MIN)} \cdot D_{MAX}}{L \cdot F_S}$$

$$I_P = \frac{I_O}{1 - D}$$

$$I_{PK} = I_P + \frac{I_{PP}}{2}$$

$$I_V = I_P - I_{PP}$$

$$I_{RMS(ON)} = \sqrt{\frac{(I_P^2 + I_{PK} \cdot I_V + I_V^2) \cdot D_{MAX}}{3}}$$

$$I_{RMS(OFF)} = \sqrt{\frac{(I_P^2 + I_{PK} \cdot I_V + I_V^2) \cdot (1 - D_{MAX})}{3}}$$

$$\begin{aligned} P_{TOTAL} &= I_{RMS(ON)}^2 \cdot (R_{DS(ON)IN} + R_{DS(ON)N}) \\ &\quad + I_{RMS(OFF)}^2 \cdot (R_{DS(ON)IN} + R_{DS(ON)P} + R_{DS(ON)}) \end{aligned}$$

$$T_{J(MAX)} = P_{TOTAL} \cdot \theta_{JA} + T_{AMB}$$

# DATA SHEET

# AAT1275

## Boost Converter with USB Power Switch

$R_{DS(ON)IN}$  is the input disconnect switch,  $R_{DS(ON)N}$  is the high-side synchronous switch,  $R_{DS(ON)P}$  is the low-side synchronous switch, and  $R_{DS(ON)}$  is the current limit load switch.

### PCB Layout Guidelines

The step-up converter performance can be adversely affected by poor layout. Possible impact includes high input and output voltage ripple, poor EMI performance, and reduced operating efficiency. Every attempt should be made to optimize the layout in order to minimize parasitic PCB effects (stray resistance, capacitance, inductance) and EMI coupling from the high frequency SW node.

A suggested PCB layout for the AAT1275 is shown in Figures 1 and 2. The following PCB layout guidelines should be considered:

1. Minimize the distance from capacitors C2 and C3 to the IC. This is especially true for the output capacitor C2, which conducts high ripple current associated with the step-up converter output capacitor.
2. Place the feedback resistor close to the output terminals. Route the output pin directly to resistor R2 to maintain good output regulation. R3 should be routed close to the output GND pin and should not share a significant return path with output capacitor C2.
3. Minimize the distance between L1 and the switching pin SW; minimize the size of the PCB area connected to the SW pin.
4. Maintain a ground plane and connect to the IC RTN pin(s), as well as the GND terminals of C1 and C2.

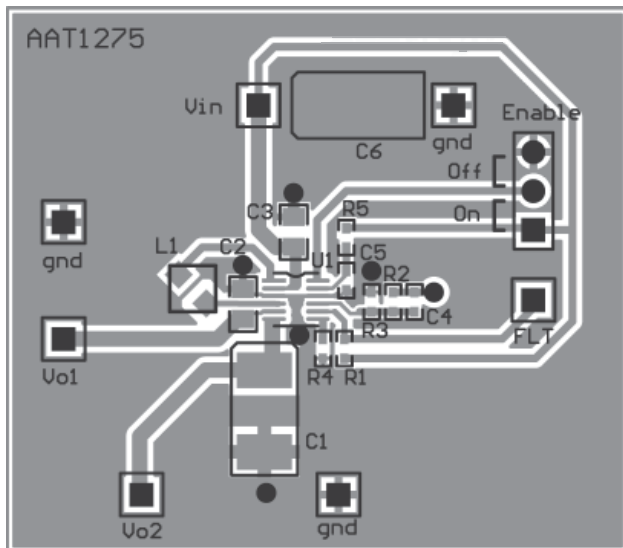

**Figure 1: AAT1275 TSOPJW-12 Package Evaluation Board Top Side Layout.**

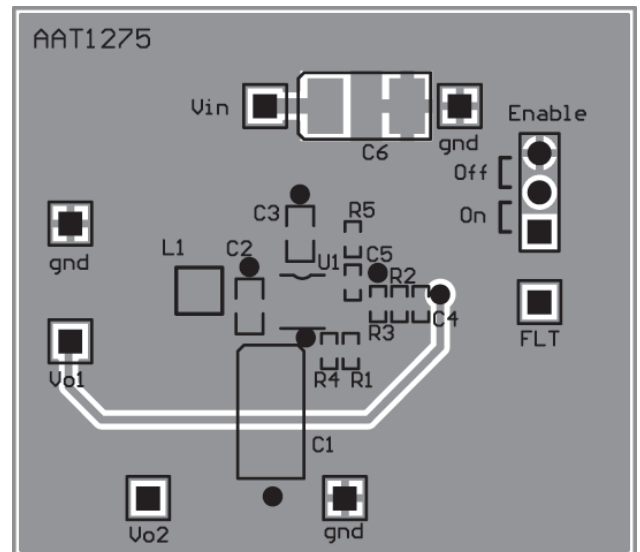

**Figure 2: AAT1275 TSOPJW-12 Package Evaluation Board Bottom Side Layout.**

# AAT1275

## Boost Converter with USB Power Switch

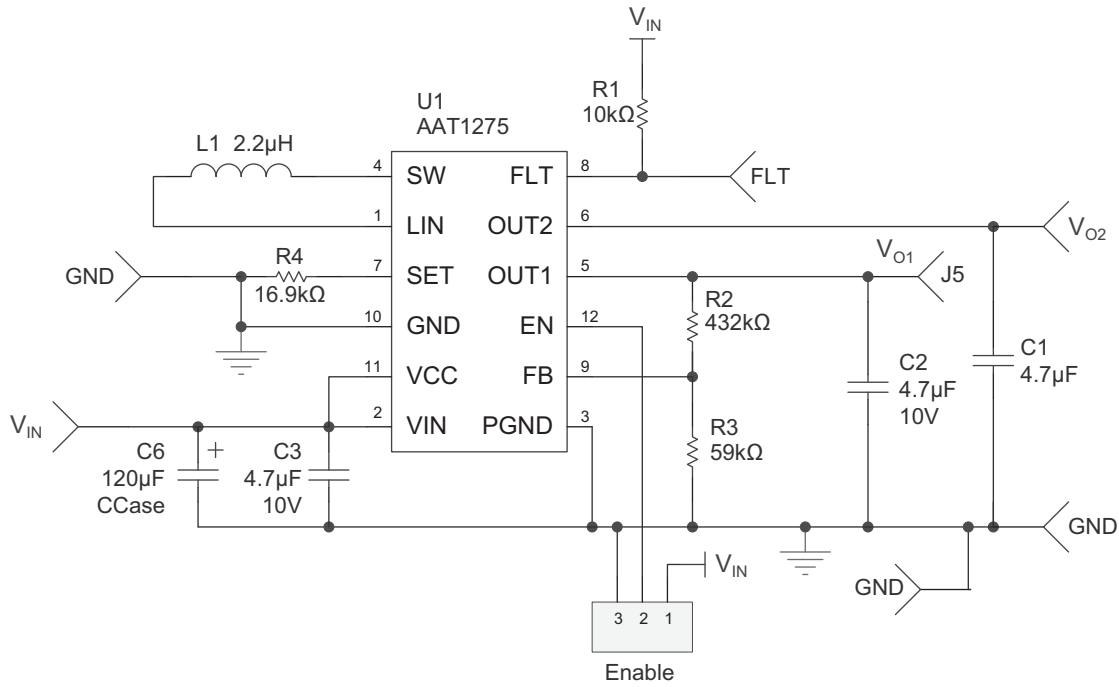

Figure 3: AAT1275 TSOPJW-12 Package Evaluation Board Schematic.

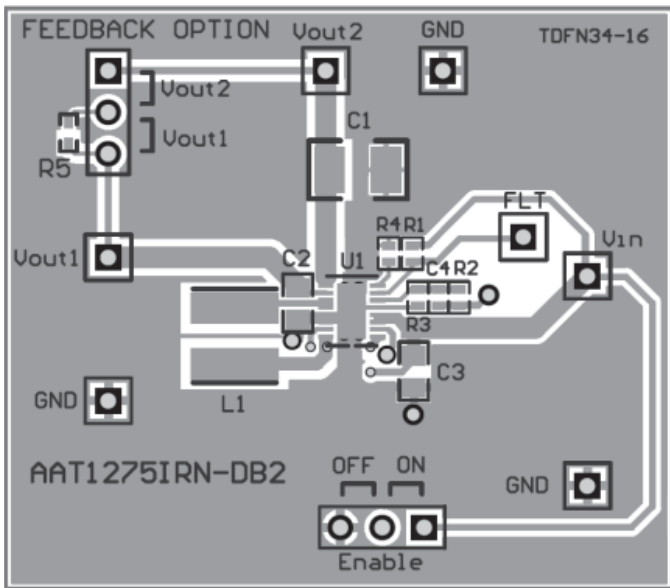

Figure 4: AAT1275 TDFN34-16 Package Evaluation Board Top Side Layout.

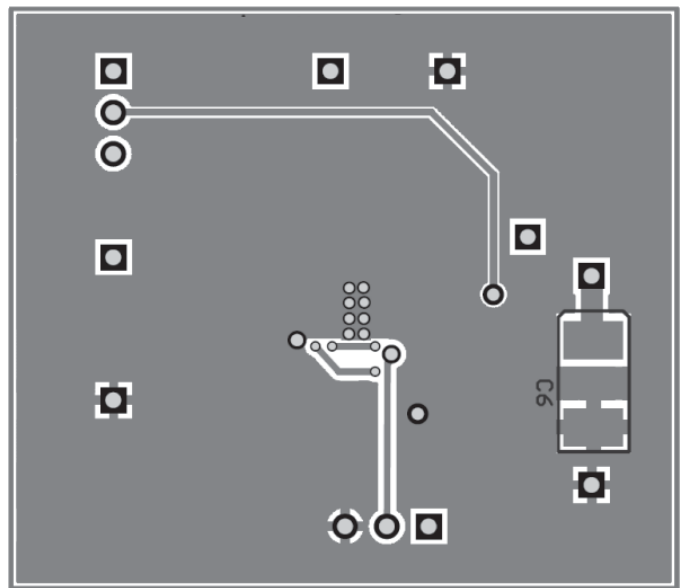

Figure 5: AAT1275 TDFN34-16 Package Evaluation Board Bottom Side Layout.



**Step-Up Converter Design Example****Specifications**

$$V_{OUT} = 5V$$

$$I_{OUT} = 300mA$$

$$V_{IN} = 2.7V \text{ to } 4.2V \text{ (3.6V nominal)}$$

$$T_{AMB} = 50^{\circ}C$$

**Output Inductor**

$$D_{MAX} = \frac{V_{OUT} - V_{IN(MIN)}}{V_{OUT}} = \frac{5V - 2.7V}{5V} = 0.46$$

From the characterization curves, the switching frequency at room temperature with a 300mA load and 2.2μH inductor is about 800kHz.

$$I_{PP} = \frac{V_{IN(MIN)} \cdot D_{MAX}}{L \cdot F_S}$$

$$I_P = \frac{I_o}{1 - D}$$

$$I_{PK} = I_P + \frac{I_{PP}}{2}$$

$$I_V = I_P - I_{PP}$$

$$I_V = I_P - I_{PP} = 0.9A - 0.7A = 0.20A$$

$$I_{RMS} = \sqrt{\frac{I_{PK}^2 + I_{PK} \cdot I_V + I_V^2}{3}} = \sqrt{\frac{0.9A^2 + 0.9A \cdot 0.2A + 0.2A^2}{3}} = 0.59A$$

For the Sumida CDRH2D14-2R2 inductor,  $I_{SAT} = 1.0A$ ,  $I_{DC(MAX)} = 1.6A$  and  $DCR = 94m\Omega$ .

$$P_{LOSS(INDUCTOR)} = I_{RMS}^2 \cdot DCR = (590mA)^2 \cdot 94m\Omega = 32mW$$

**5V Output Capacitor**

$$\Delta V_{OUT} = 0.05V$$

$$C_{OUT(MIN)} = \frac{I_{OUT} \cdot D_{MAX}}{F_S \cdot \Delta V_{OUT}} = \frac{0.3A \cdot 0.46}{800kHz \cdot 0.05V} = 3.0\mu F; \text{ use } 4.7\mu F \text{ } 10V \text{ MLC}$$



**Boost Converter with USB Power Switch****AAT1275 Losses**

$$I_{\text{RMS(ON)}} = \sqrt{\frac{(I_{\text{PK}}^2 + I_{\text{PK}} \cdot I_{\text{V}} + I_{\text{V}}^2) \cdot D_{\text{MAX}}}{3}} = \sqrt{\frac{(0.9\text{A}^2 + 0.9\text{A} \cdot 0.2\text{A} + 0.2\text{A}^2) \cdot 0.46}{3}} = 0.4\text{A}$$

$$I_{\text{RMS(OFF)}} = \sqrt{\frac{(I_{\text{PK}}^2 + I_{\text{PK}} \cdot I_{\text{V}} + I_{\text{V}}^2) \cdot (1 - D_{\text{MAX}})}{3}} = \sqrt{\frac{(0.9\text{A}^2 + 0.9\text{A} \cdot 0.2\text{A} + 0.2\text{A}^2) \cdot (1 - 0.46)}{3}} = 0.43\text{A}$$

$$P_{\text{TOTAL}} = I_{\text{RMS(ON)}}^2 \cdot (R_{\text{DS(ON)IN}} + R_{\text{DS(ON)N}}) + I_{\text{RMS(OFF)}}^2 \cdot (R_{\text{DS(ON)IN}} + R_{\text{DS(ON)P}} + R_{\text{DS(ON)}})$$

$$= 0.4\text{A}^2 \cdot (0.25\Omega + 0.3\Omega) + 0.42^2 \cdot (0.25\Omega + 0.3\Omega + 0.2\Omega) = 0.22\text{W}$$

$$T_{\text{J(MAX)}} = P_{\text{TOTAL}} \cdot \theta_{\text{JA}} + T_{\text{AMB}} = 0.22\text{W} \cdot \frac{110^\circ\text{C}}{\text{W}} + 85^\circ\text{C} = 109^\circ\text{C}$$

# AAT1275

## Boost Converter with USB Power Switch

### Ordering Information

Package	Marking <sup>1</sup>	Part Number (Tape and Reel) <sup>2</sup>
TSOPJW-12	USXYY	<b>AAT1275ITP-5.0-T1</b>
TDFN34-16	USXYY	<b>AAT1275IRN-5.0-T1</b>



Skyworks Green™ products are compliant with all applicable legislation and are halogen-free.

For additional information, refer to *Skyworks Definition of Green™*, document number SQ04-0074.

### Package Information<sup>3</sup>

#### TSOPJW-12

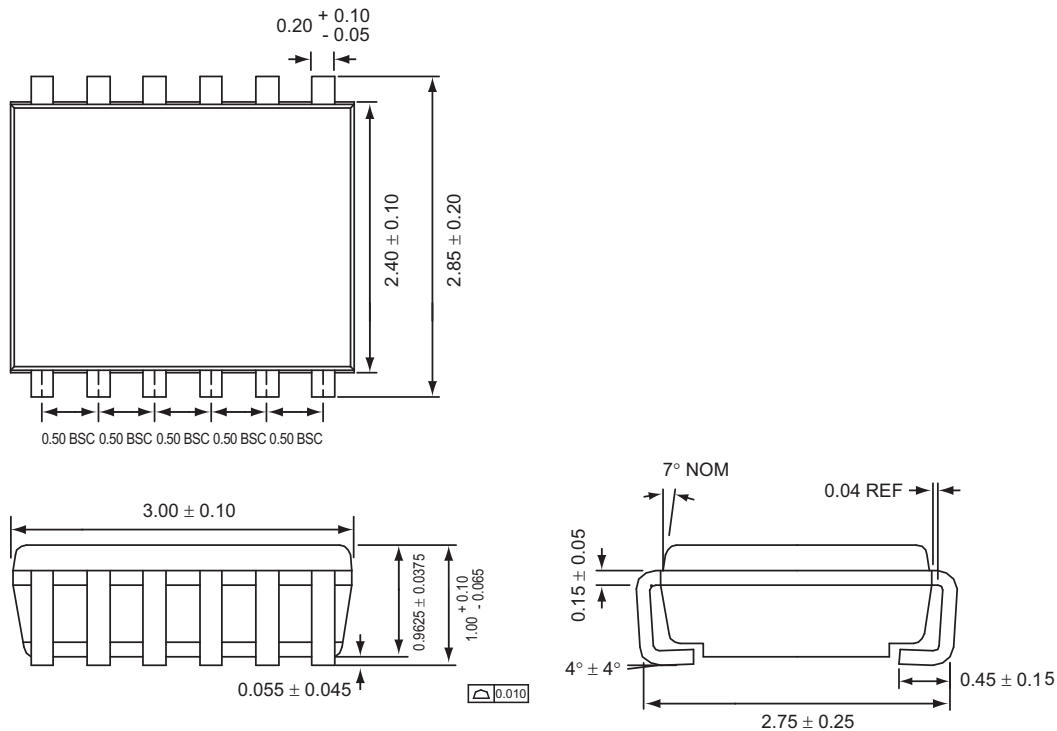

All dimensions in millimeters.

1. XYY = assembly and date code.
2. Sample stock is generally held on part numbers listed in **BOLD**.
3. The leadless package family, which includes QFN, TQFN, DFN, TDFN and STDN, has exposed copper (unplated) at the end of the lead terminals due to the manufacturing process. A solder fillet at the exposed copper edge cannot be guaranteed and is not required to ensure a proper bottom solder connection.

## Boost Converter with USB Power Switch

### TDFN34-16

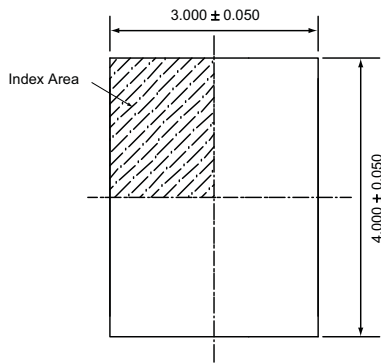

Top View

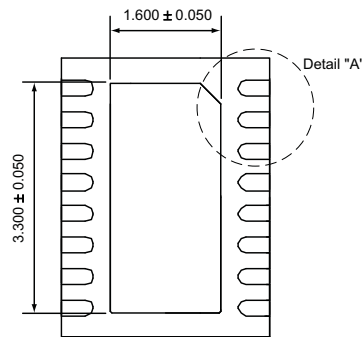

Bottom View

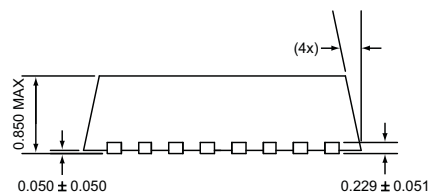

Side View

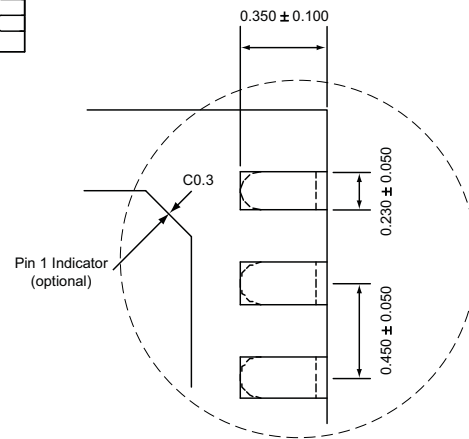

Detail "A"

All dimensions in millimeters.

Copyright © 2012, 2013 Skyworks Solutions, Inc. All Rights Reserved.

Information in this document is provided in connection with Skyworks Solutions, Inc. ("Skyworks") products or services. These materials, including the information contained herein, are provided by Skyworks as a service to its customers and may be used for informational purposes only by the customer. Skyworks assumes no responsibility for errors or omissions in these materials or the information contained herein. Skyworks may change its documentation, products, services, specifications or product descriptions at any time, without notice. Skyworks makes no commitment to update the materials or information and shall have no responsibility whatsoever for conflicts, incompatibilities, or other difficulties arising from any future changes.

No license, whether express, implied, by estoppel or otherwise, is granted to any intellectual property rights by this document. Skyworks assumes no liability for any materials, products or information provided hereunder, including the sale, distribution, reproduction or use of Skyworks products, information or materials, except as may be provided in Skyworks Terms and Conditions of Sale.

THE MATERIALS, PRODUCTS AND INFORMATION ARE PROVIDED "AS IS" WITHOUT WARRANTY OF ANY KIND, WHETHER EXPRESS, IMPLIED, STATUTORY, OR OTHERWISE, INCLUDING FITNESS FOR A PARTICULAR PURPOSE OR USE, MERCHANTABILITY, PERFORMANCE, QUALITY OR NON-INFRINGEMENT OF ANY INTELLECTUAL PROPERTY RIGHT; ALL SUCH WARRANTIES ARE HEREBY EXPRESSLY DISCLAIMED. SKYWORKS DOES NOT WARRANT THE ACCURACY OR COMPLETENESS OF THE INFORMATION, TEXT, GRAPHICS OR OTHER ITEMS CONTAINED WITHIN THESE MATERIALS. SKYWORKS SHALL NOT BE LIABLE FOR ANY DAMAGES, INCLUDING BUT NOT LIMITED TO ANY SPECIAL, INDIRECT, INCIDENTAL, STATUTORY, OR CONSEQUENTIAL DAMAGES, INCLUDING WITHOUT LIMITATION, LOST REVENUES OR LOST PROFITS THAT MAY RESULT FROM THE USE OF THE MATERIALS OR INFORMATION, WHETHER OR NOT THE RECIPIENT OF MATERIALS HAS BEEN ADVISED OF THE POSSIBILITY OF SUCH DAMAGE.

Skyworks products are not intended for use in medical, lifesaving or life-sustaining applications, or other equipment in which the failure of the Skyworks products could lead to personal injury, death, physical or environmental damage. Skyworks customers using or selling Skyworks products for use in such applications do so at their own risk and agree to fully indemnify Skyworks for any damages resulting from such improper use or sale.

Customers are responsible for their products and applications using Skyworks products, which may deviate from published specifications as a result of design defects, errors, or operation of products outside of published parameters or design specifications. Customers should include design and operating safeguards to minimize these and other risks. Skyworks assumes no liability for applications assistance, customer product design, or damage to any equipment resulting from the use of Skyworks products outside of stated published specifications or parameters.

Skyworks, the Skyworks symbol, and "Breakthrough Simplicity" are trademarks or registered trademarks of Skyworks Solutions, Inc., in the United States and other countries. Third-party brands and names are for identification purposes only, and are the property of their respective owners. Additional information, including relevant terms and conditions, posted at [www.skyworksinc.com](http://www.skyworksinc.com), are incorporated by reference.